

*R***IROS**
Surfaces

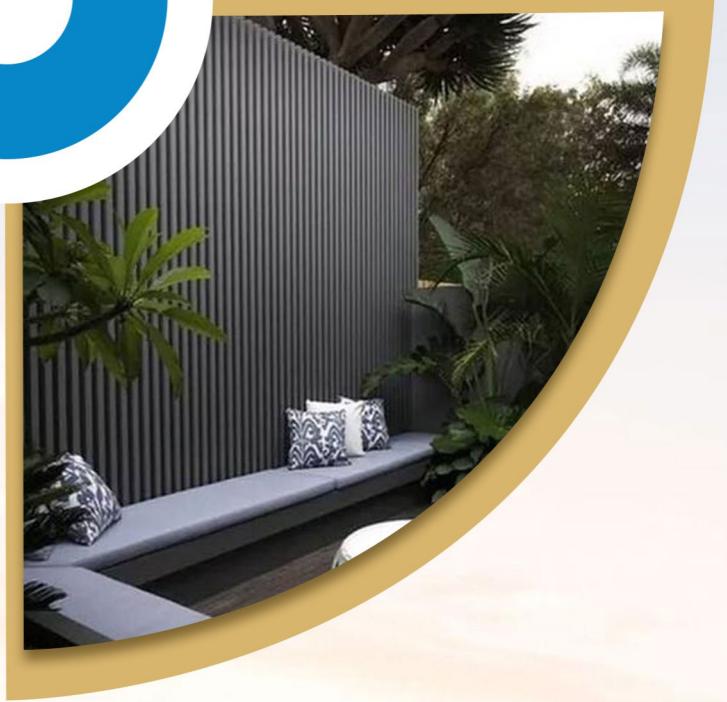

LIVE
BY THE **NATURE**
WPC EXTERIOR



**WPC EXTERIOR
CLADDING & DECKING**

SHRUTI
PLASTWOOD CREATIONS

 Shrutiplastwood.com

WPC EXTERIOR CLADDING & DECKING

FEATURES



**ALL WEATHER
CONDITIONS**



**HIGHLY
DURABLE**



**TERMITE
PROOF**



**ECO
FRIENDLY**



**UV
RESISTANT**



**WATER
PROOF**



**LOW
MAINTENANCE**

INSTALLATION INSTRUCTIONS

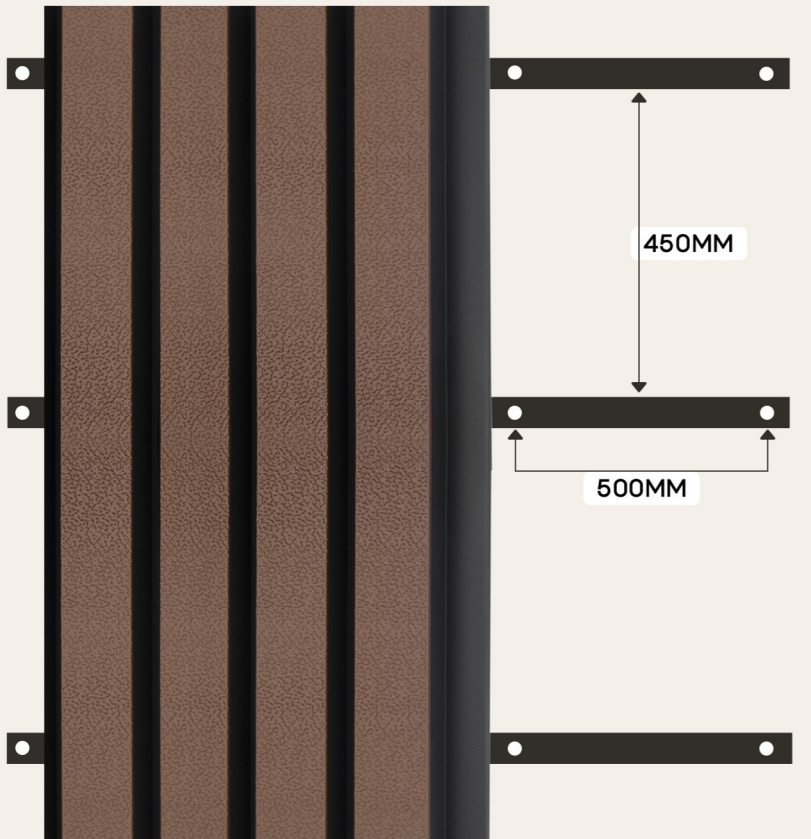

1. Install the aluminum channels onto the wall using expansion screws placed at 450 mm intervals. Ensure that the spacing between each screw is 500 mm.

2. Double aluminum channels are required at the end-to-end joint between two cladding boards to ensure that both boards are adequately supported by the aluminum channels.

3. Leave an expansion gap of approximately 8 mm between the ends of two cladding boards to prevent the risk of cracking and warping.

4. Always pre-drill pilot holes before driving screws to prevent damage to the cladding board.

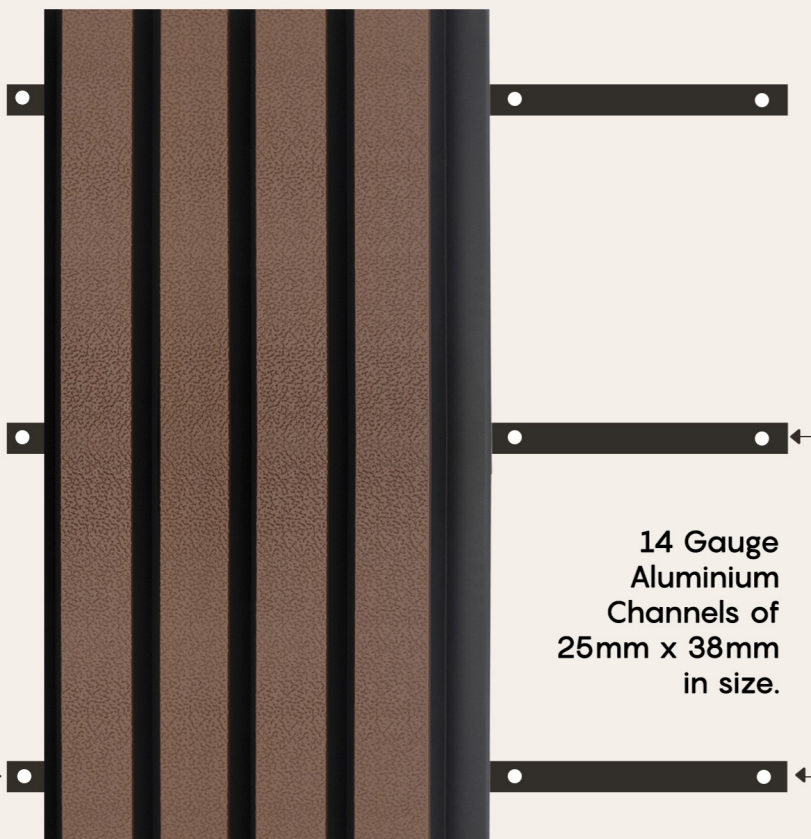

14 Gauge
Aluminium
Channels of
25mm x 38mm
in size.

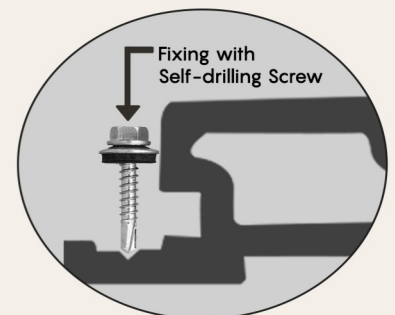

Fixing with
Self-drilling Screw

Screw
after
15 mm
from
board
end

Warranty is applicable only when the product is installed according to the given instructions.



**T
R
E
D
L
O
O
K**



**FULL CAP
SERIES**



RW - 301(A)

WPC CLADDING



RW - 302 (A)

WPC CLADDING

Thickness - 23MM

Per Panel Area - 6.85 sqft



RW - 303 (A)

WPC CLADDING



RW - 304 (A)

WPC CLADDING

R
IROS
Surfaces

— 220 MM —

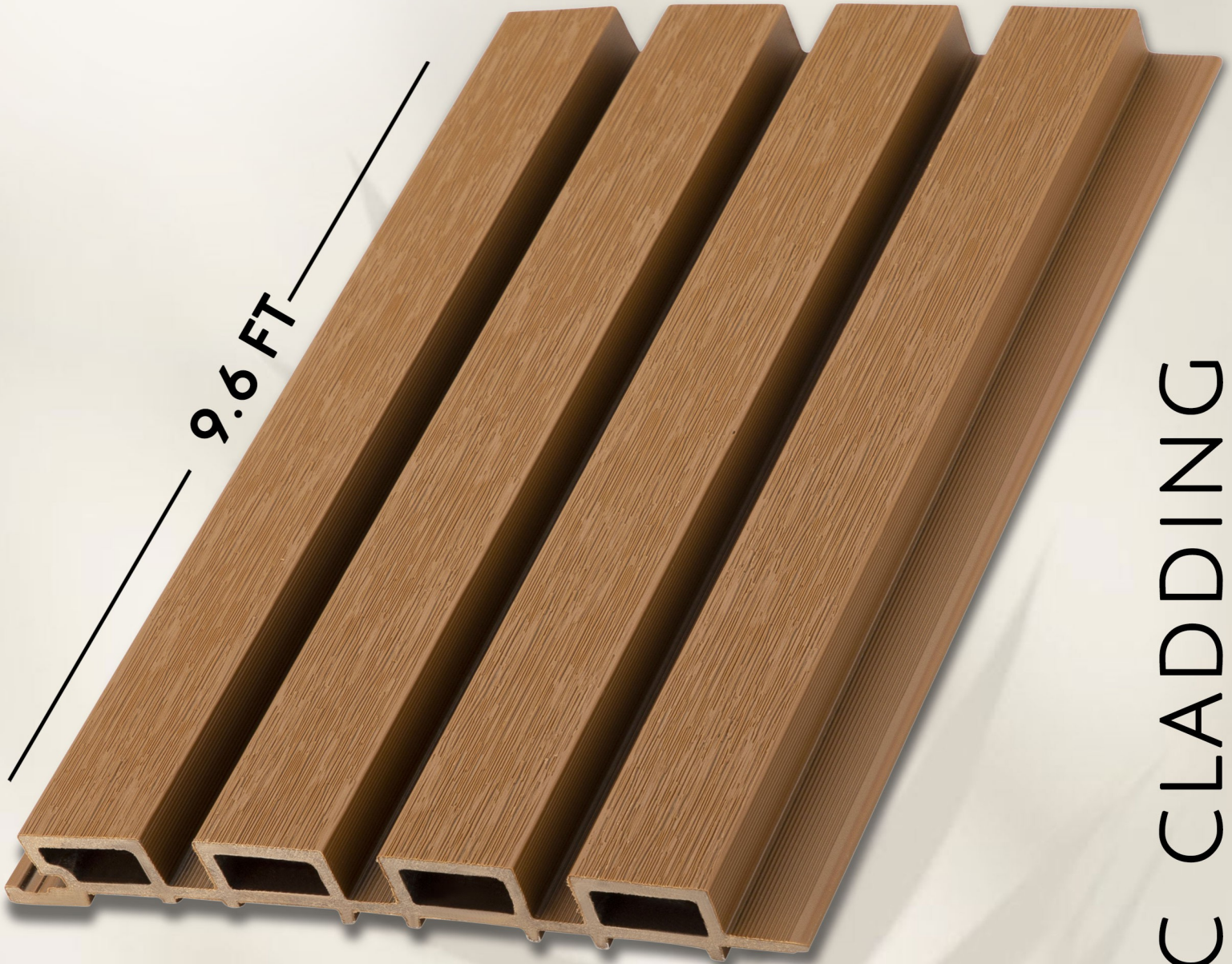

9.6 FT

WPC CLADDING

RW - 401 (A)

Thickness - 25MM

Per Panel Area - 6.85 sqft

SHRUTI
PLASTWOOD CREATIONS

R
IROS
Surfaces

— 220 MM —

9.6 FT

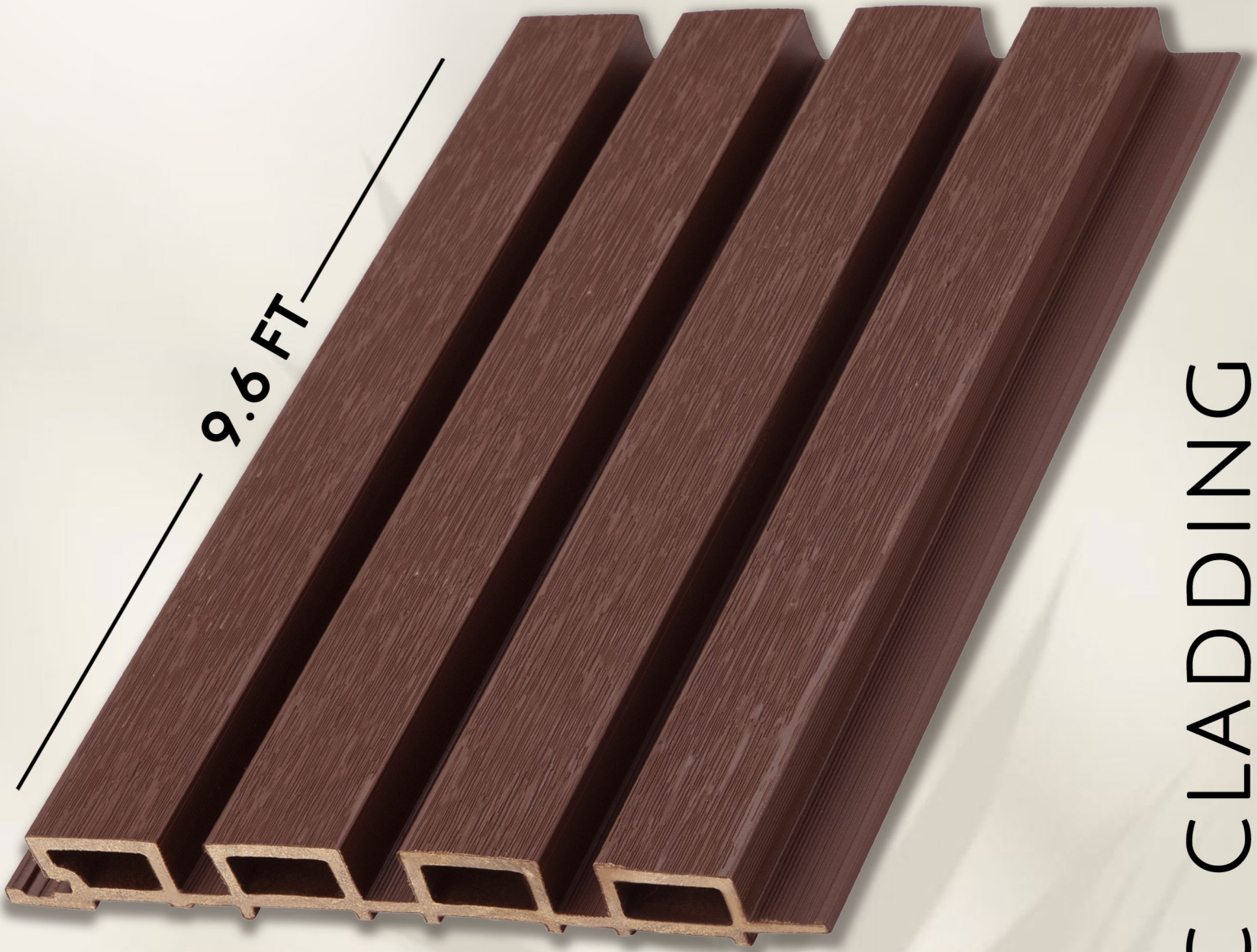

WPC CLADDING

RW - 402 (A)

Thickness - 25MM

Per Panel Area - 6.85 sqft

SHRUTI
PLASTWOOD CREATIONS

R
IROS
Surfaces

220 MM

9.6 FT

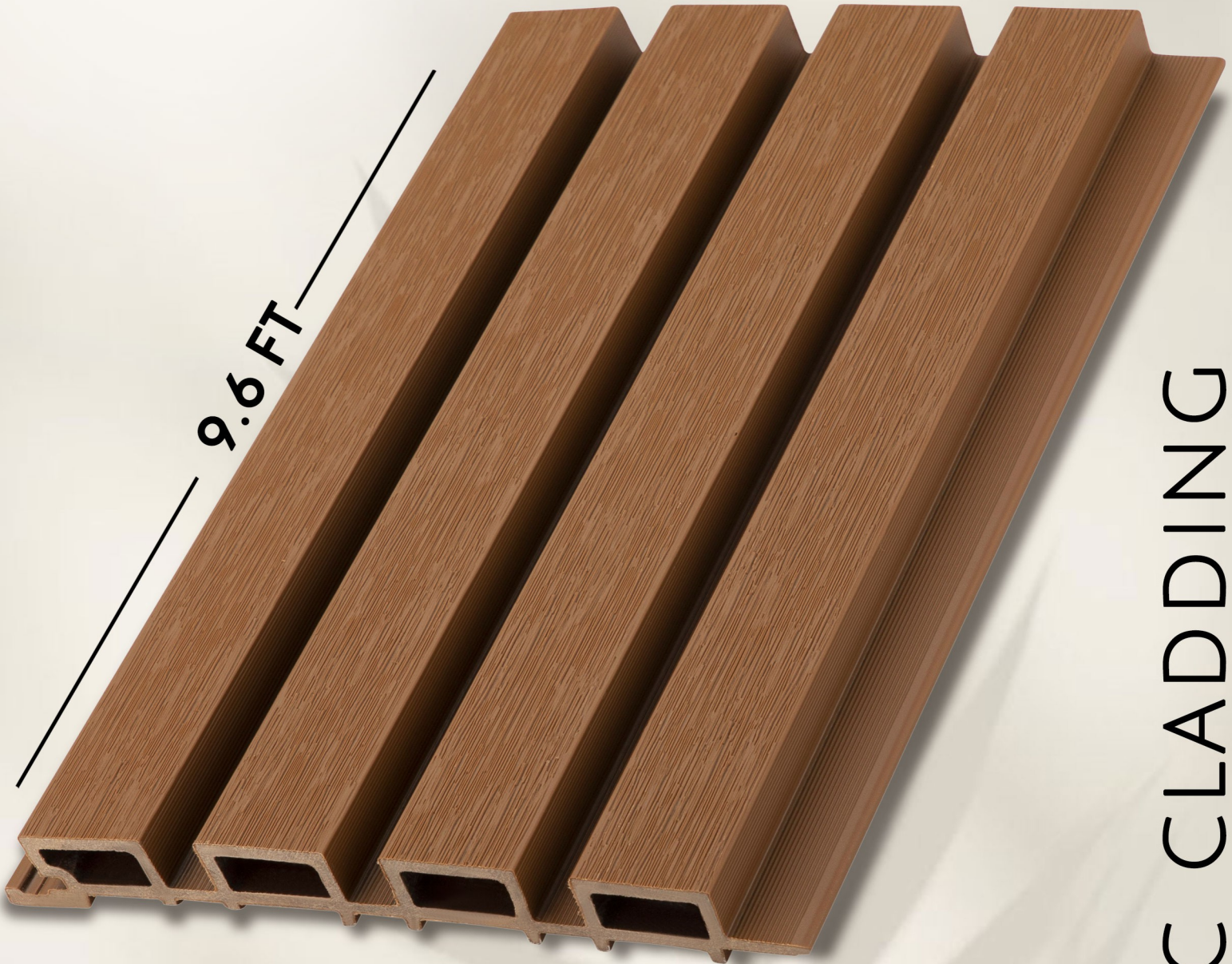

WPC CLADDING

RW - 403 (A)

Thickness - 25MM

Per Panel Area - 6.85 sqft

SHRUTI
PLASTWOOD CREATIONS

R
IROS
Surfaces

— 220 MM —

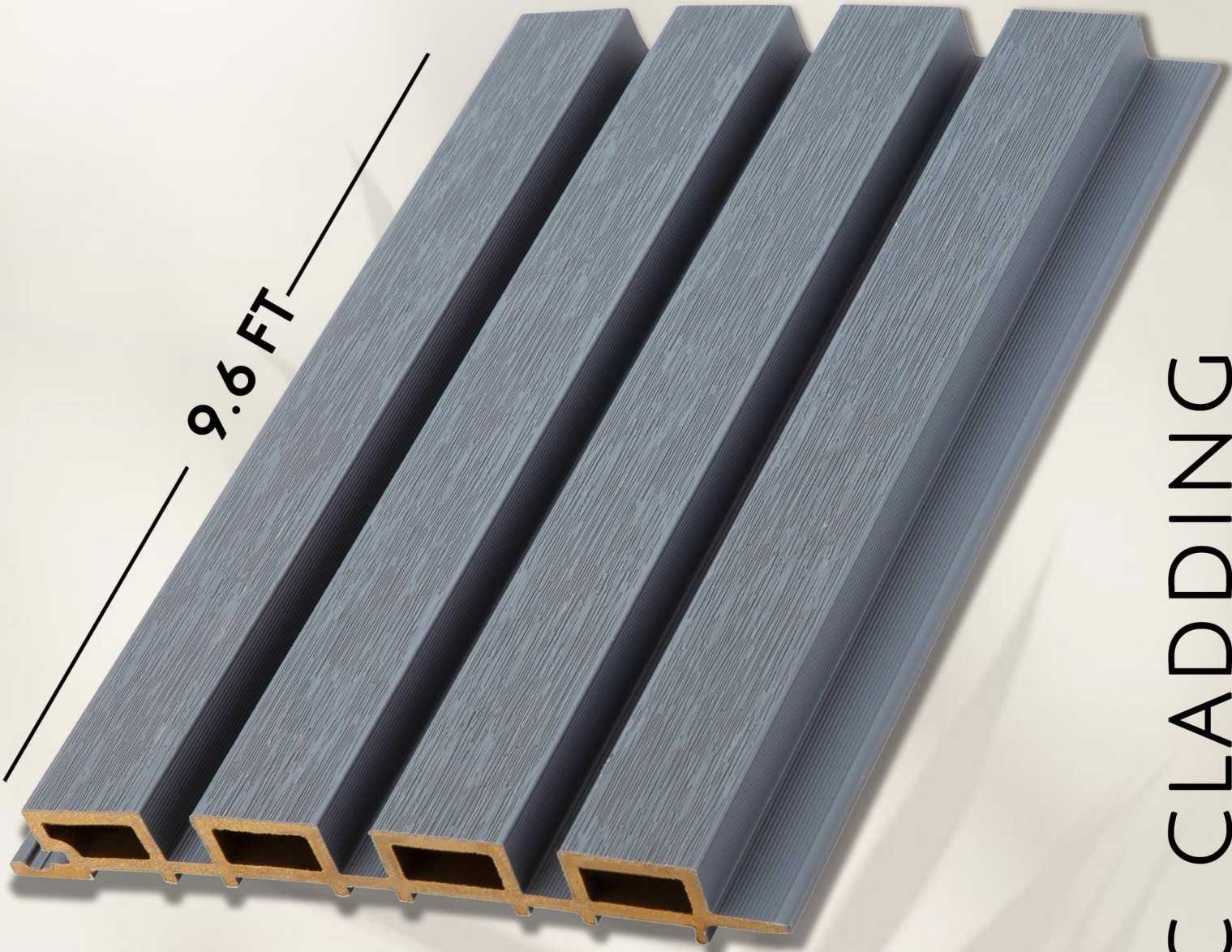

9.6 FT

WPC CLADDING

RW - 404 (A)

Thickness - 25MM

Per Panel Area - 6.85 sqft

SHRUTI
PLASTWOOD CREATIONS

R
IROS
Surfaces

220 MM

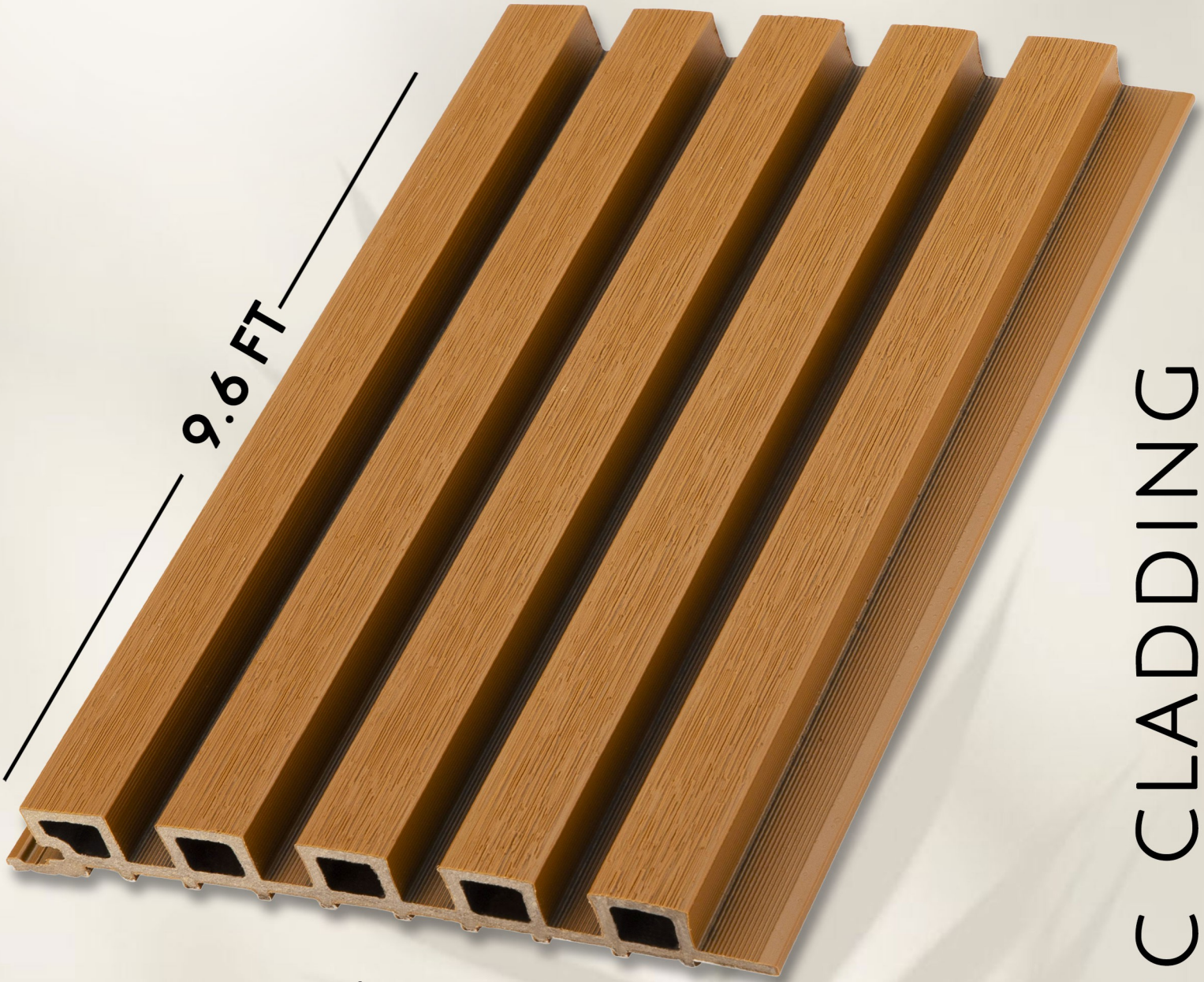

9.6 FT

WPC CLADDING

RW - 501 (A)

Thickness - 25MM

Per Panel Area - 6.85 sqft

SHRUTI
PLASTWOOD CREATIONS

R
IROS
Surfaces

— 220 MM —

9.6 FT

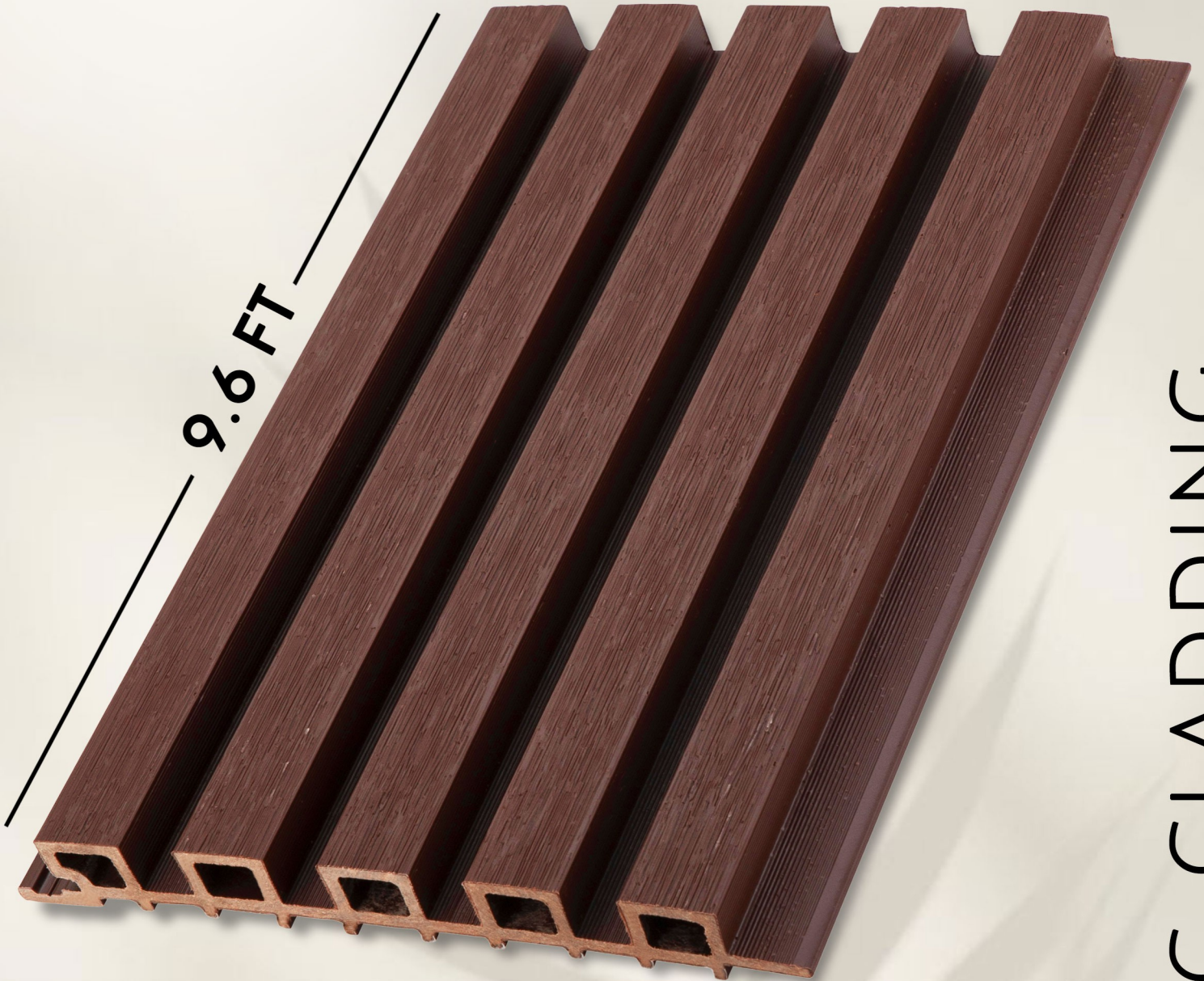

RW - 502 (A)

WPC CLADDING



SHRUTI
PLASTWOOD CREATIONS

Thickness - 25MM

Per Panel Area - 6.85 sqft

R
IROS
Surfaces

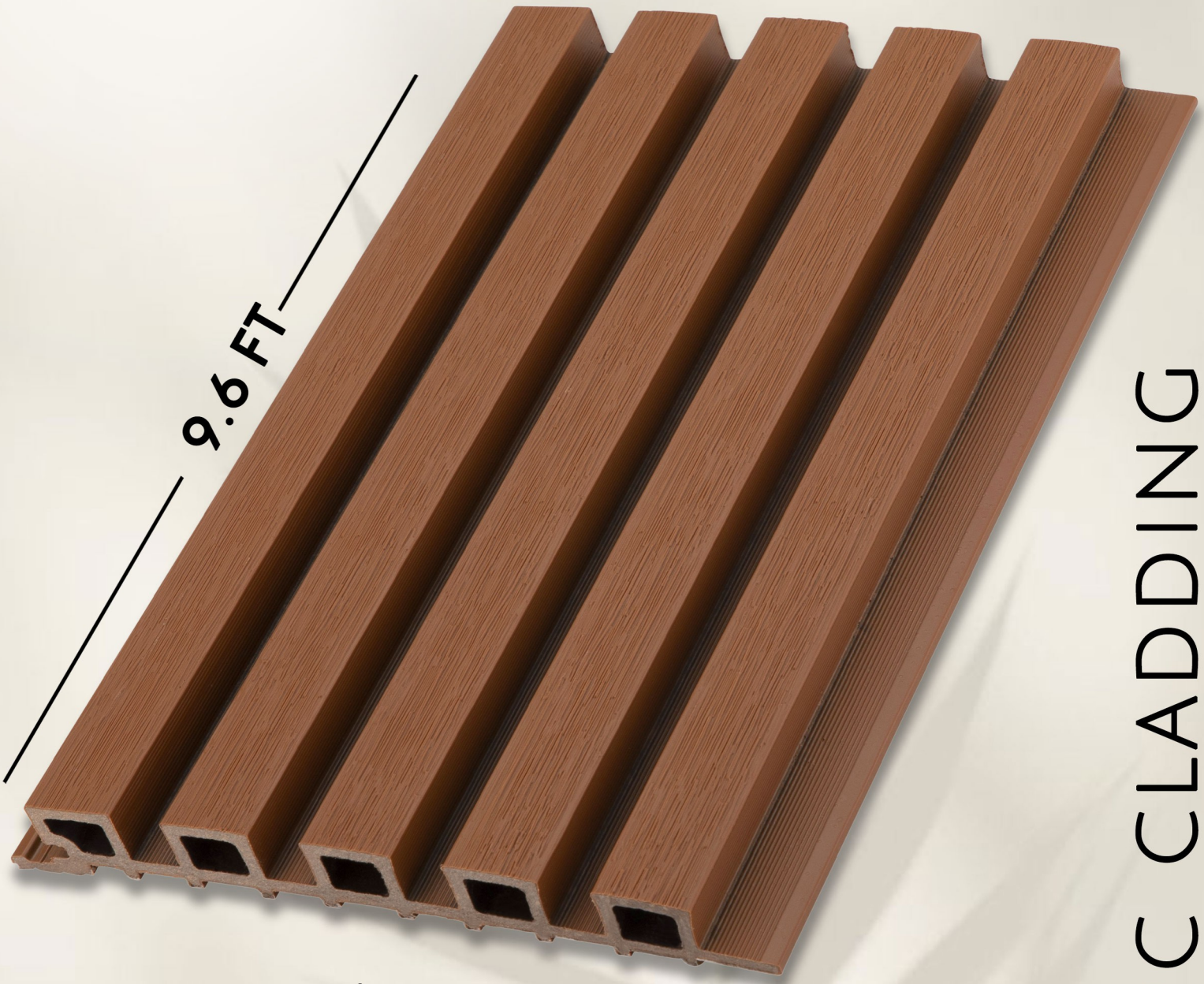
— 220 MM —



9.6 FT

RW - 503 (A)

WPC CLADDING

SHRUTI
PLASTWOOD CREATIONS

Thickness - 25MM

Per Panel Area - 6.85 sqft

R
IROS
Surfaces

220 MM

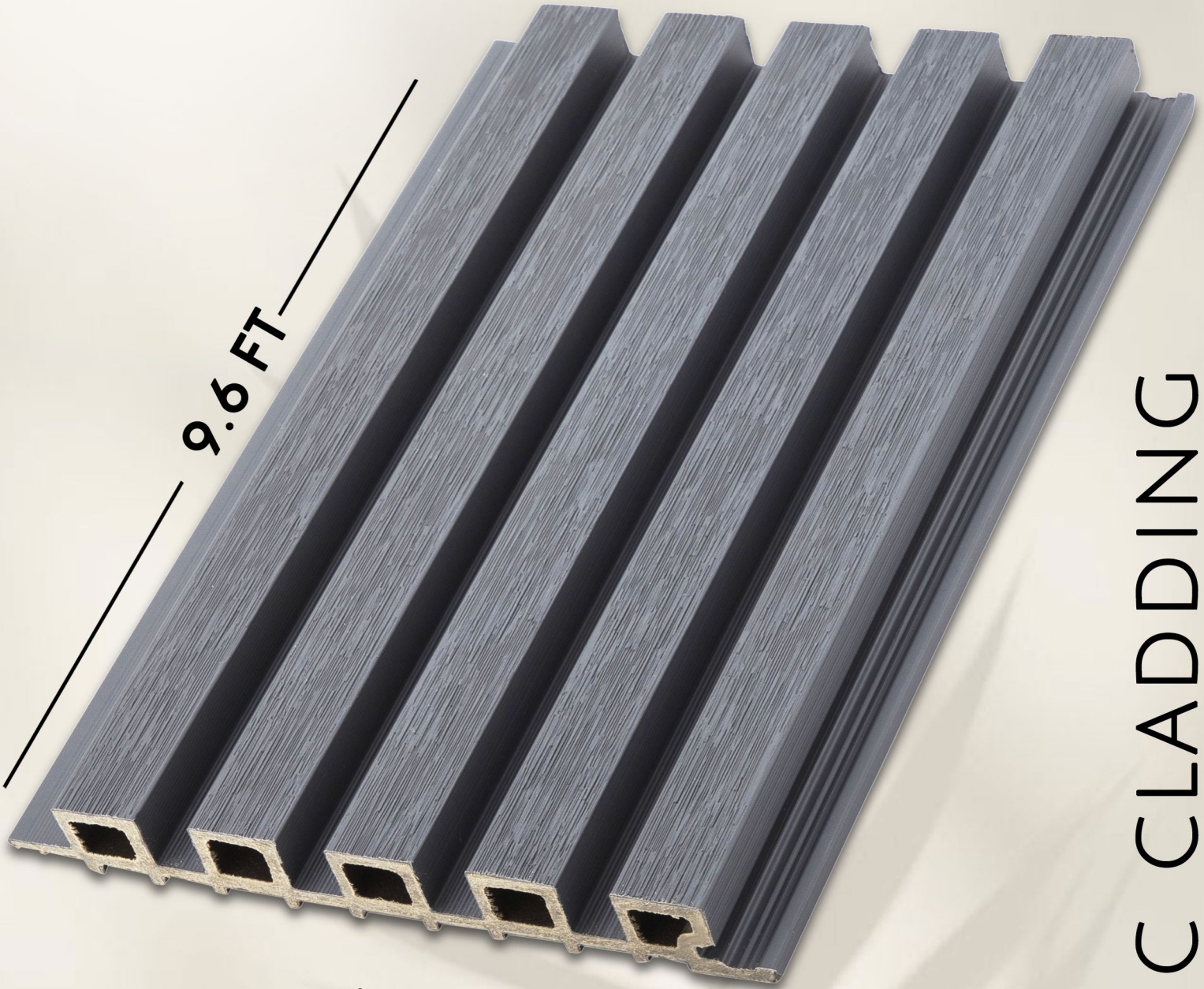

9.6 FT

RW - 504 (A)

WPC CLADDING

**SHRUTI**
PLASTWOOD CREATIONS

Thickness - 25MM

Per Panel Area - 6.85 sqft



ARTFULLY
BLENDED
STYLE &
DESIGN

**HALF CAP
SERIES**

R
IROS
Surfaces

220 MM

9.6 FT

WPC CLADDING

RWH - 421

Thickness - 25MM

Per Panel Area - 6.85 sqft

SHRUTI
PLASTWOOD CREATIONS

R
IROS
Surfaces

220 MM

9.6 FT

RWH - 422

WPC CLADDING

Thickness - 25MM

Per Panel Area - 6.85 sqft

SHRUTI
PLASTWOOD CREATIONS

R
IROS
Surfaces

220 MM

9.6 FT

WPC CLADDING

RWH - 423

Thickness - 25MM

Per Panel Area - 6.85 sqft

SHRUTI
PLASTWOOD CREATIONS

R
IROS
Surfaces

220 MM

9.6 FT

WPC CLADDING

RWH - 424

Thickness - 25MM

Per Panel Area - 6.85 sqft

SHRUTI
PLASTWOOD CREATIONS

R
IROS
Surfaces

220 MM

9.6 FT

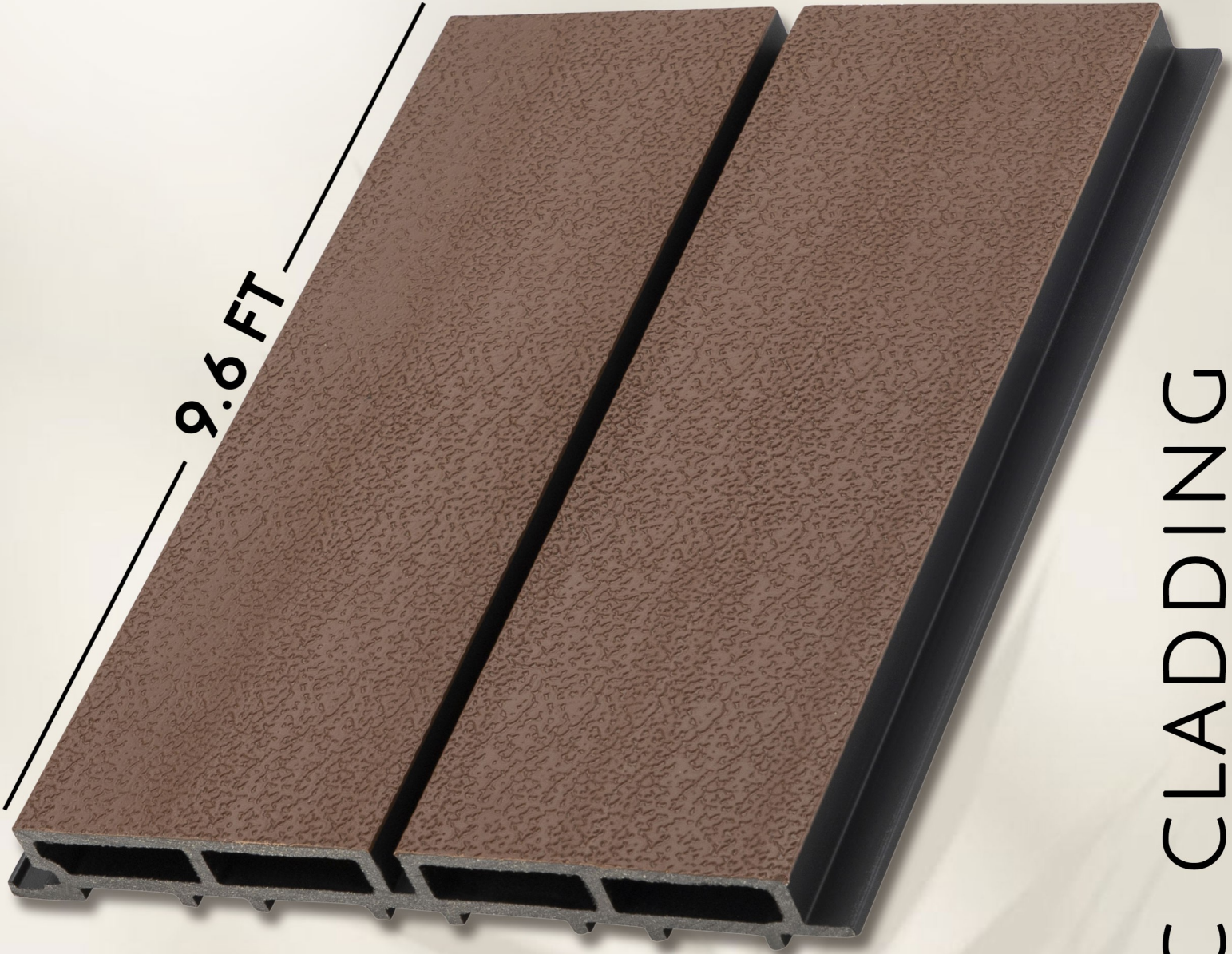

RWH - 201

WPC CLADDING

**SHRUTI**
PLASTWOOD CREATIONS

Thickness - 25MM

Per Panel Area - 6.85 sqft

R
IROS
Surfaces

— 220 MM —

9.6 FT



WPC CLADDING

RWH - 202

Thickness - 25MM

Per Panel Area - 6.85 sqft

SHRUTI
PLASTWOOD CREATIONS

R
IROS
Surfaces

220 MM

9.6 FT

WPC CLADDING

RWH - 203

Thickness - 25MM

Per Panel Area - 6.85 sqft

R
IROS
Surfaces

— 220 MM —

9.6 FT

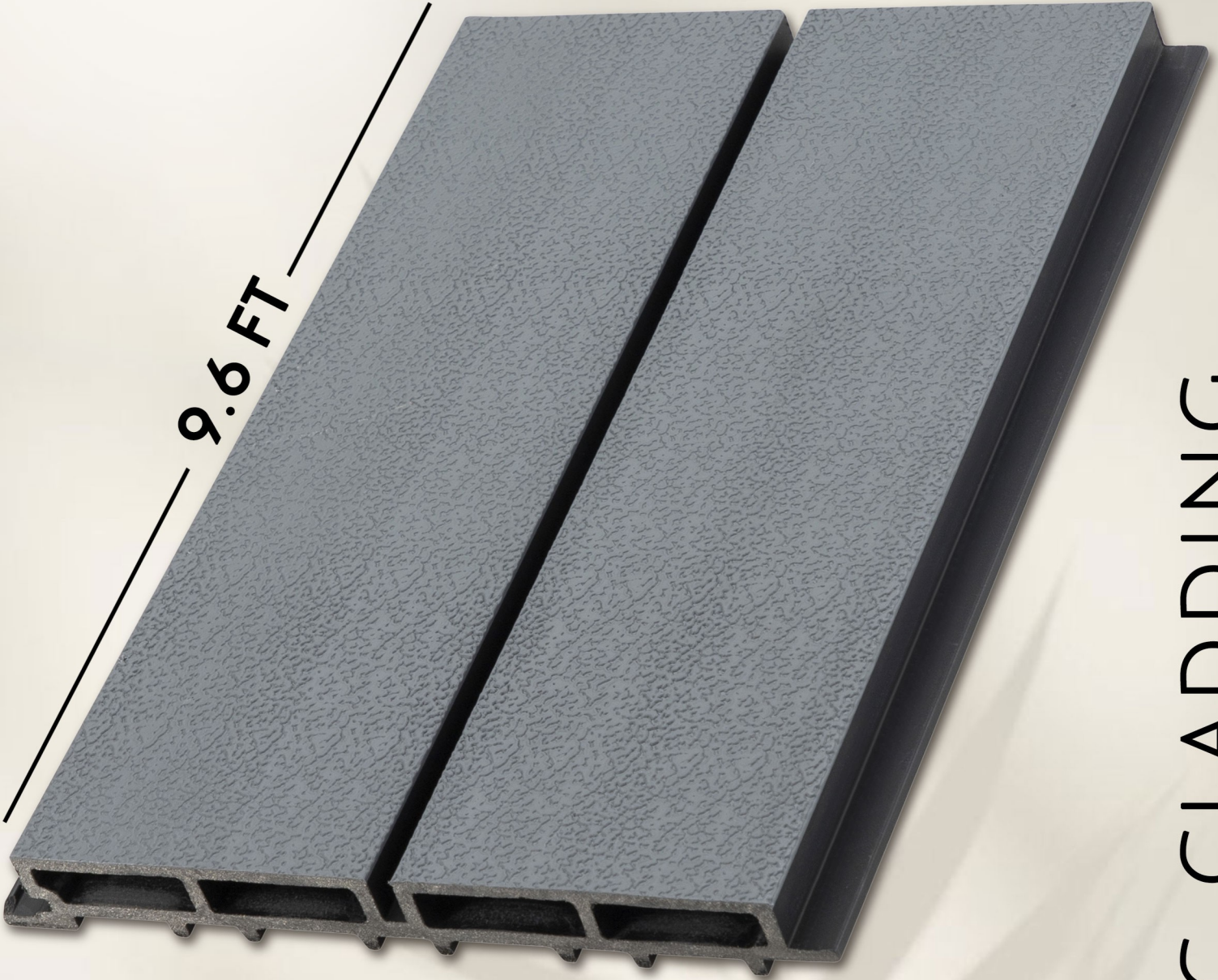

RWH - 204

WPC CLADDING

SHRUTI
PLASTWOOD CREATIONS

Thickness - 25MM

Per Panel Area - 6.85 sqft

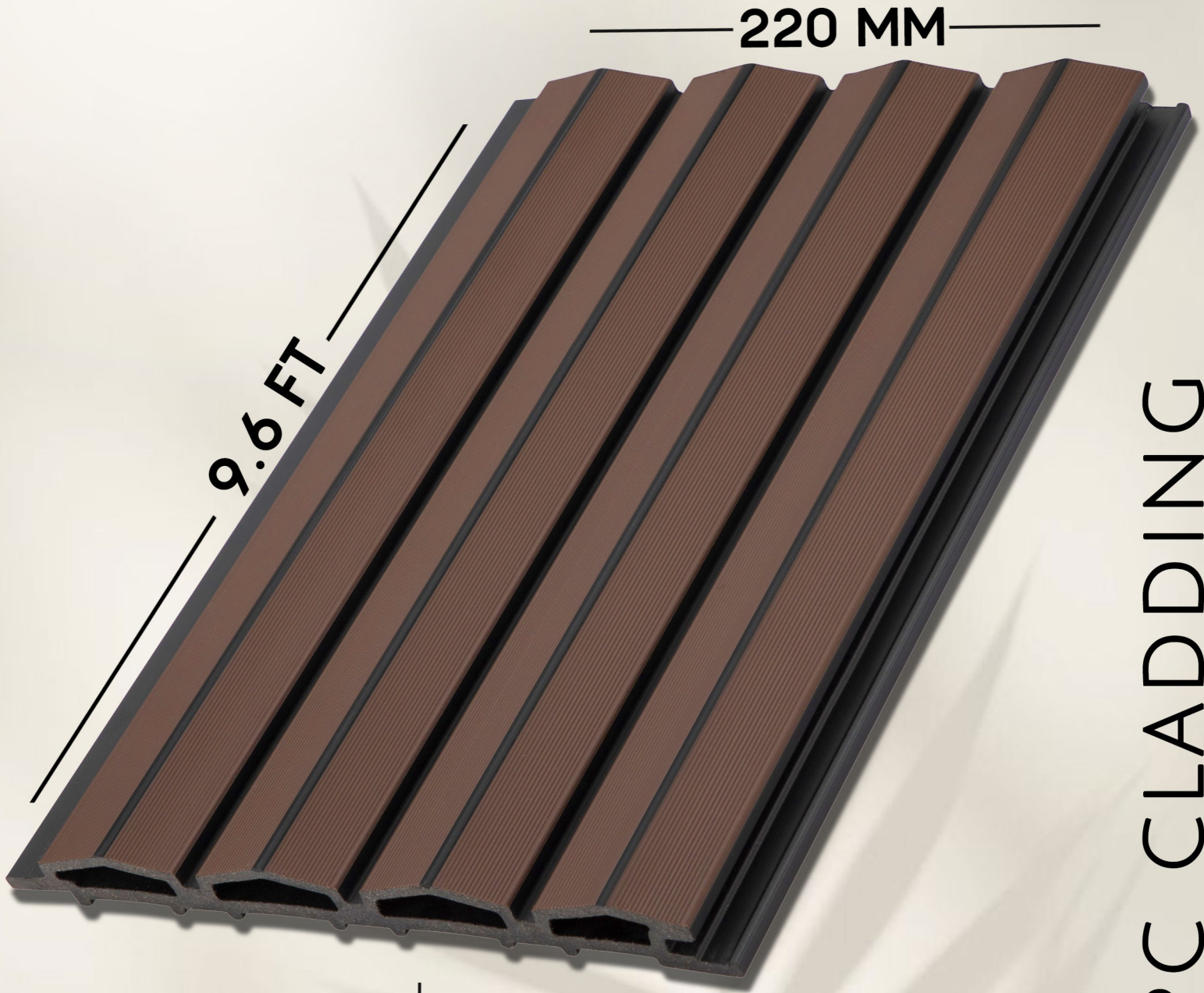

WPC CLADDING

RWH - 321

Thickness - 23MM

Per Panel Area - 6.85 sqft

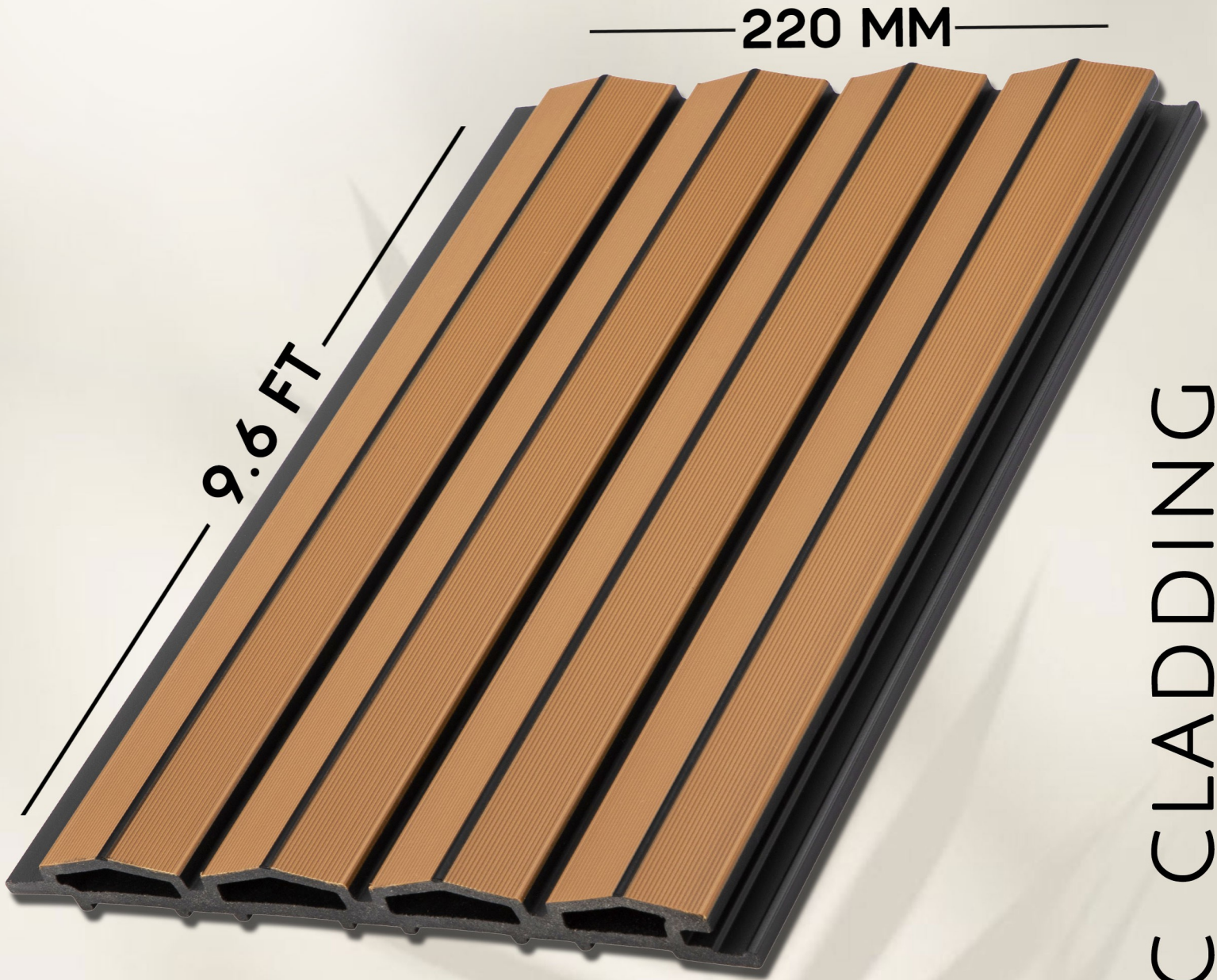

WPC CLADDING

RWH - 322

Thickness - 23MM

Per Panel Area - 6.85 sqft

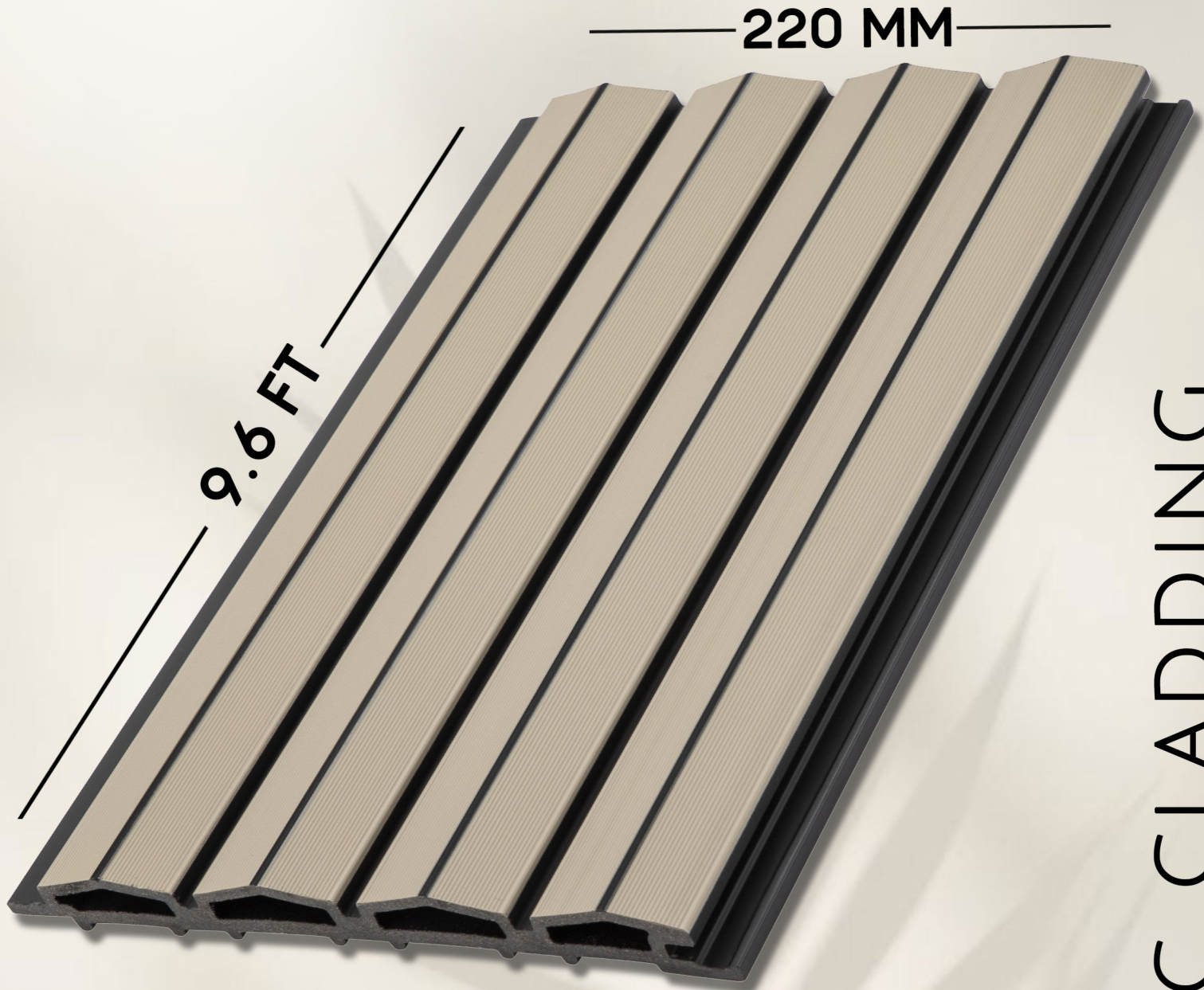

WPC CLADDING

RWH - 323

Thickness - 23MM

Per Panel Area - 6.85 sqft

— 220 MM —

9.6 FT

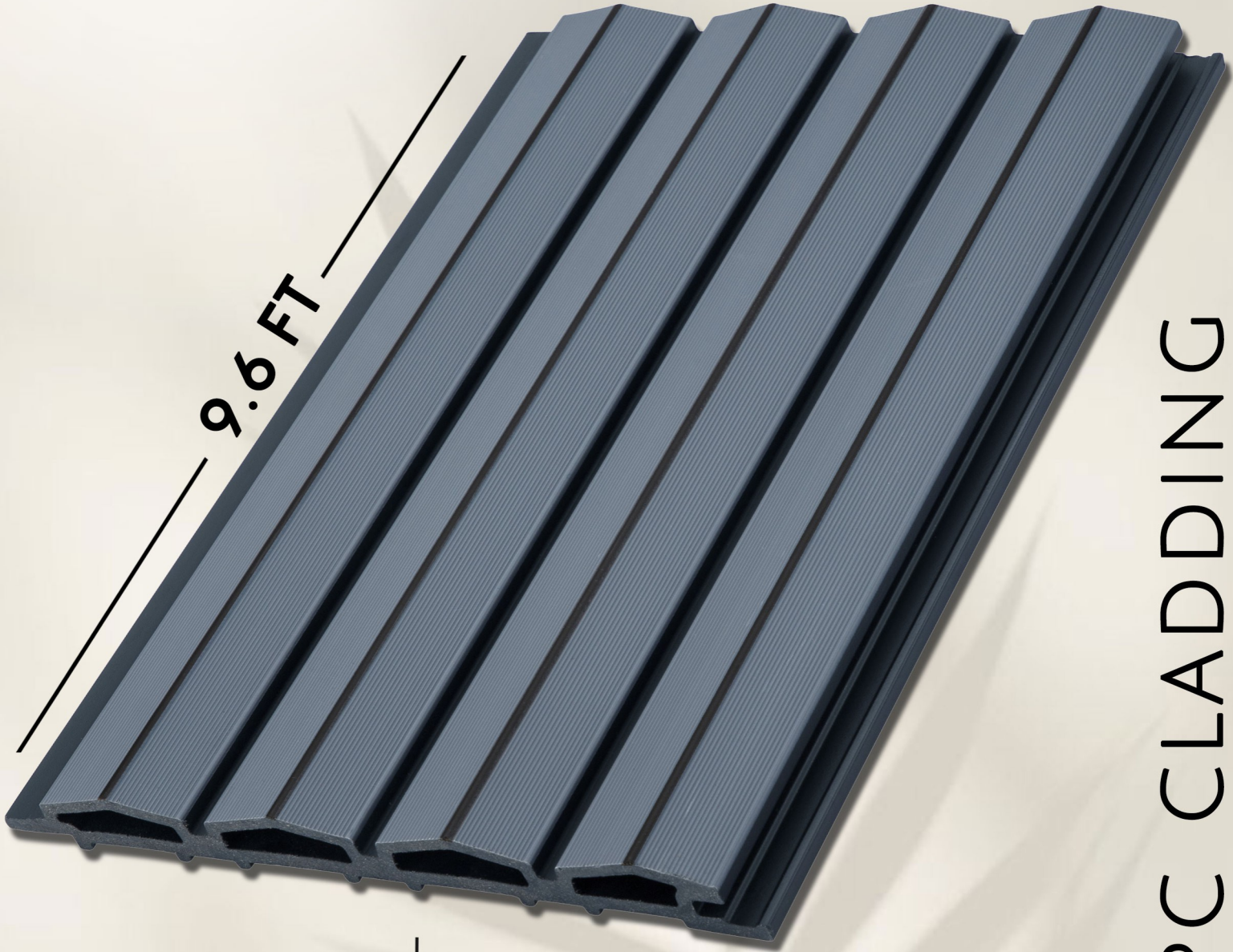

RWH - 324

WPC CLADDING

Thickness - 23MM

Per Panel Area - 6.85 sqft



WPC DECKING



YOU ALWAYS HAVE A

Choice.

R
IROS
Surfaces

150 MM

9.6 FT

RWD -101

WPC DECKING

SHRUTI
PLASTWOOD CREATIONS

Thickness - 23MM

Per Panel Area - 4.75 sqft

R
IROS
Surfaces

150 MM

9.6 FT

RWD -102

WPC DECKING

SHRUTI
PLASTWOOD CREATIONS

Thickness - 23MM

Per Panel Area - 4.75 sqft

R
IROS
Surfaces

150 MM

9.6 FT

RWD -104

WPC DECKING

SHRUTI
PLASTWOOD CREATIONS

Thickness - 23MM

Per Panel Area - 4.75 sqft

R
IROS
Surfaces

150 MM

9.6 FT

RWD -105

WPC DECKING

SHRUTI
PLASTWOOD CREATIONS

Thickness - 23MM

Per Panel Area - 4.75 sqft

WPC

L

TAKE STEPS TOWARDS

Elegance

R
IROS
Surfaces

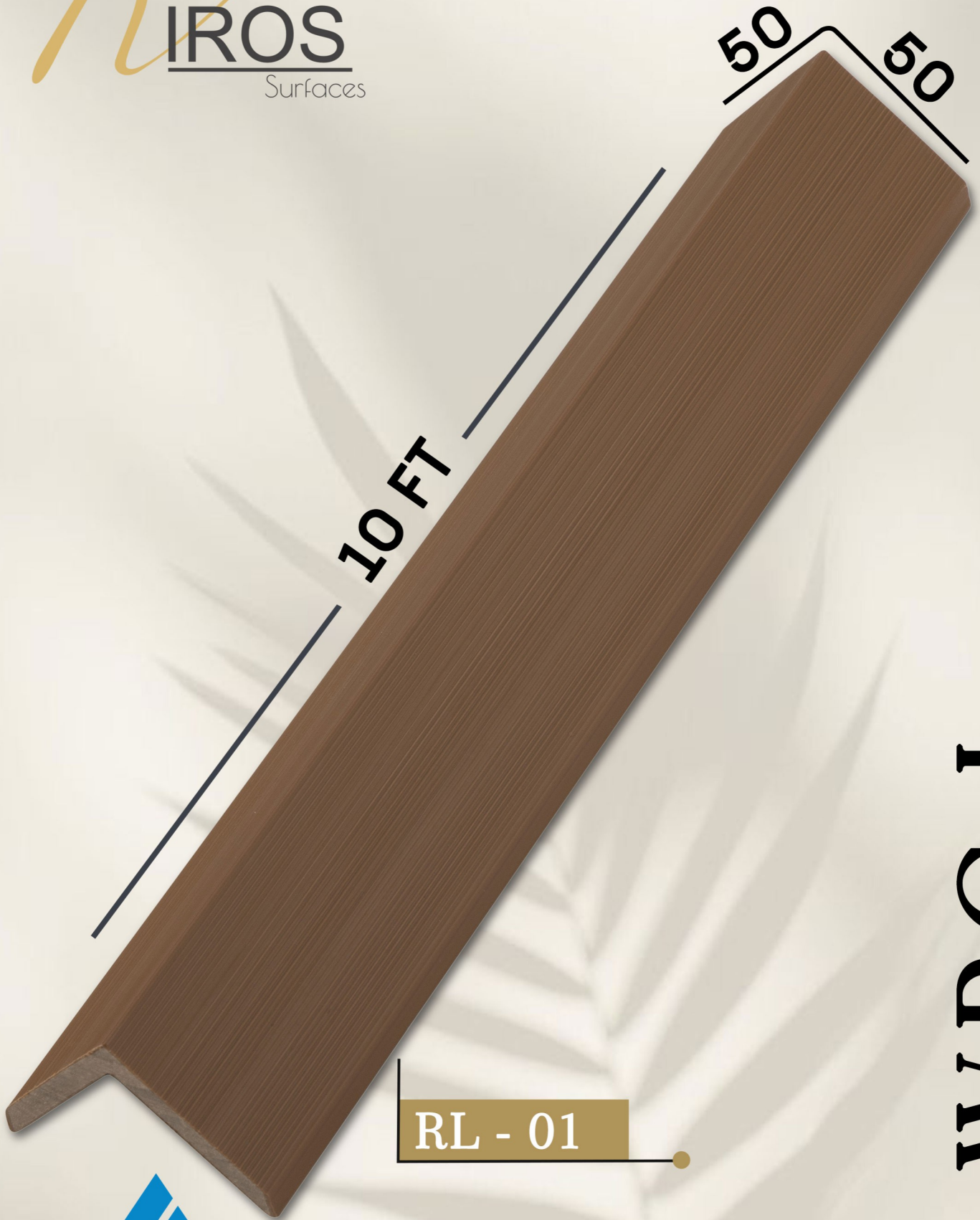

RL - 01

WPC L

SHRUTI
PLASTWOOD CREATIONS

R
IROS
Surfaces



WPC L

SHRUTI
PLASTWOOD CREATIONS

R
IROS
Surfaces

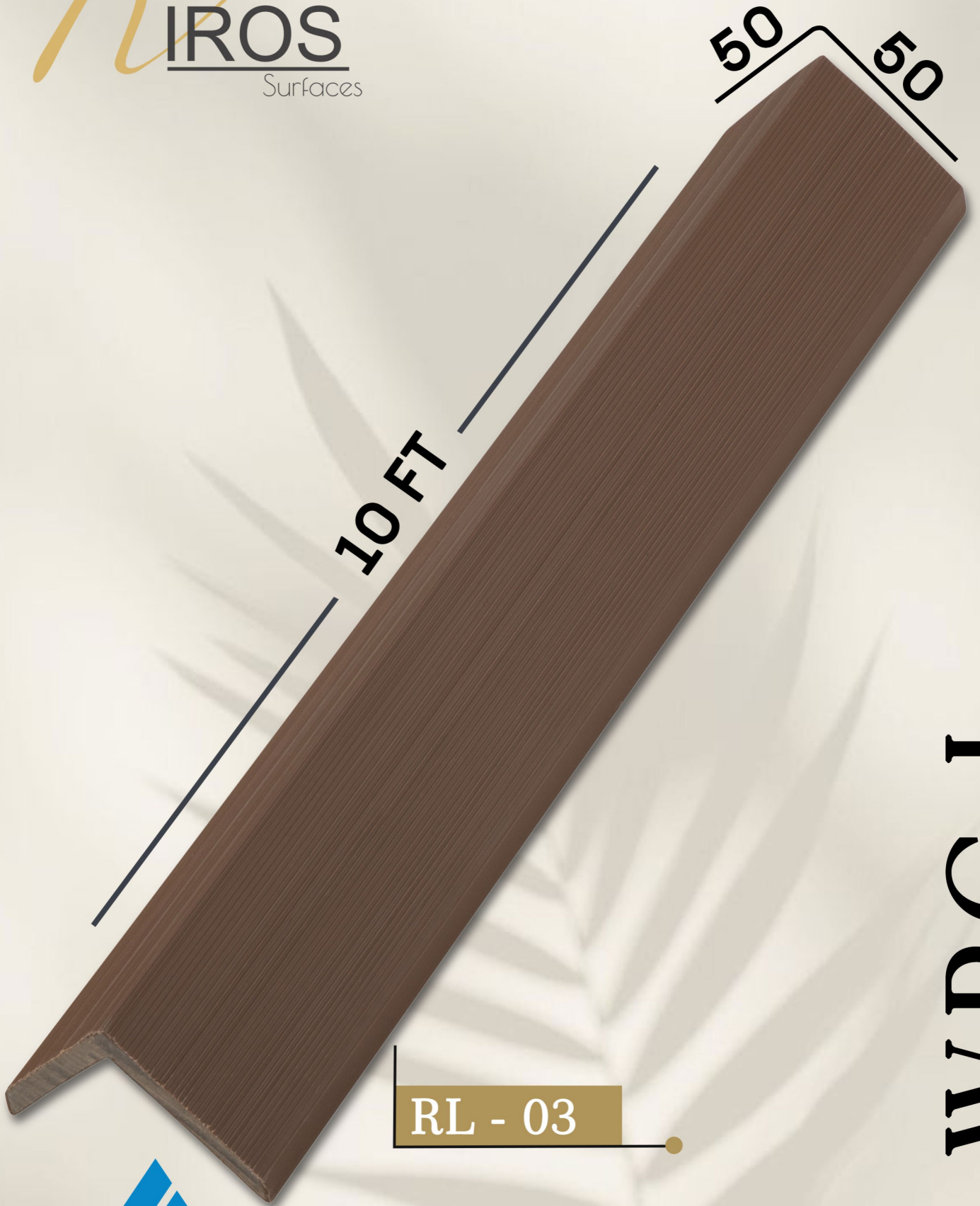

RL - 03

WPC L

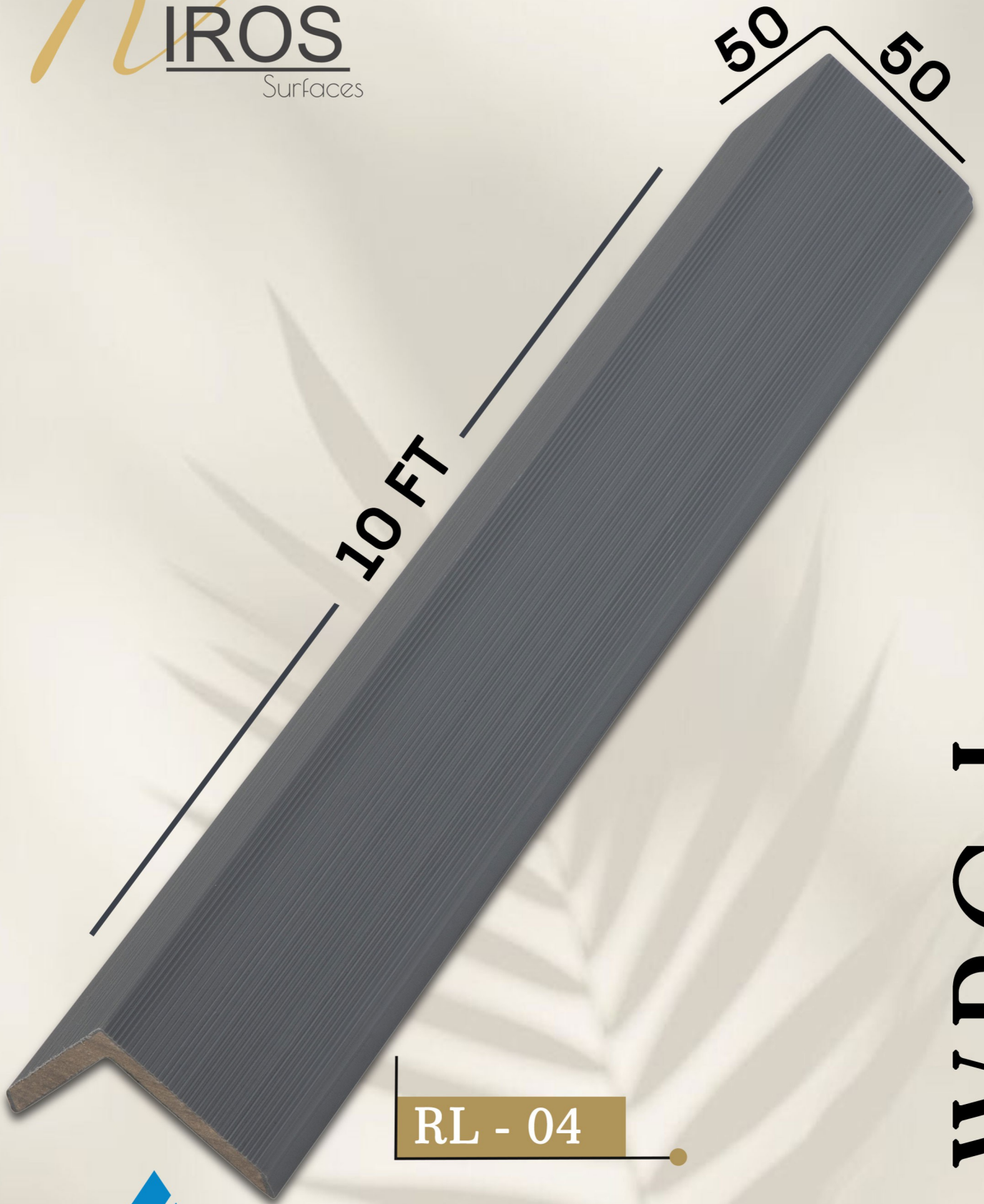

SHRUTI
PLASTWOOD CREATIONS



WPC L

RL - 04

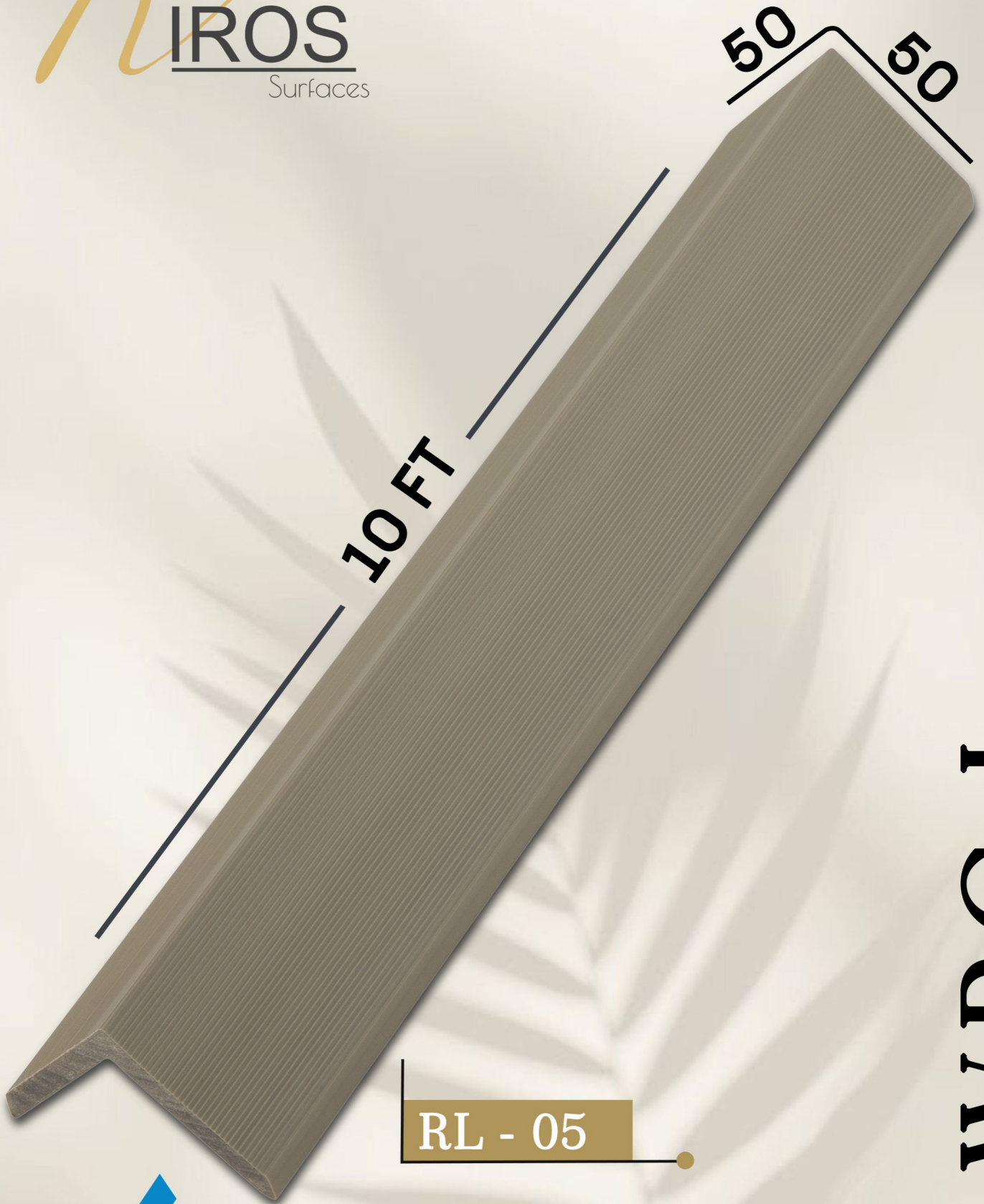
R
IROS
Surfaces



WPC L

SHRUTI
PLASTWOOD CREATIONS

R
IROS
Surfaces



RL - 06

WPC L

SHRUTI
PLASTWOOD CREATIONS



RIROS SURFACES - WPC EXTERIOR LIMITED WARRANTY STAIN & FADE RESISTANCE

THIS LIMITED WARRANTY ("THE LIMITED WARRANTY") IS MADE AND GIVEN BY SHRUTI PRINTPACK PRIVATE LIMITED. ("SHRUTI"). SHRUTI MANUFACTURES WPC EXTERIOR PRODUCTS UNDER THE BRAND NAME OF RIROS SURFACES. ALL REFERENCES IN THIS LIMITED WARRANTY TO RIROS SURFACES ARE REFERENCES TO SHRUTI PRINTPACK PRIVATE LIMITED.

RIROS SURFACES warrants the stain and fade resistance to the original purchaser ("Purchaser", "You" or "Your") of the RIROS SURFACES WPC Exterior Product noted below that, for the specified Warranty Period, such product shall (1) under normal and proper service conditions, (2) when installed in accordance with RIROS SURFACES written instructions. However, no material is fade or stain proof, especially but not only when subjected to years of exposure to UV rays (ultraviolet rays) & elements, or exposure to extreme heat sources whether directly or indirectly, or when food or other substances are spilled on the surface are not cleaned immediately and properly.

For the Purpose of Limited Warranty, the "Original Purchaser" means the individual or individuals who were the owners of the real property upon which the Riros Surfaces - WPC Exterior product was installed.

The term of the Limited Warranty (Warranty Period) for the Riros Surfaces - WPC Exterior product shall be Ten years (10 years) as per below mentioned claim schedule, from the date of original purchase provided that such purchaser maintains the ownership of the real property upon which the Riros Surface product was installed, and shall produce the original bill of purchase of the product.

Prorated Limited Warranty Schedule

Year of Claim	Claim
0-5 Years	100%
5-8 Years	50%
8-10 Years	25%

Damaging, scratching, rubbing or puncturing the surface of the Riros Surfaces - WPC Exterior product voids all warranties in their entirety.

Paint or applying any other coating materials to Riros Surfaces - WPC Exterior product voids all warranties in their entirety.

This Limited Warranty applies only to Riros Surfaces - WPC Exterior product installed in India.

The court at sonapat Haryana alone will have the Jurisdiction for adjudication of disputes if any related to limited Warranty.